

DALLAS DISTRICT
Design Schematic
William L. Hale, P.E.
District Engineer

SH 121
From: FM 2499
To: Denton Creek

Dallas County
CSJ: 0364-02-017
CSJ: 0364-03-064
Functional Class: Urban Freeway
Project Length: 1.94 Miles
Design Speed: Mainlanes 70 mph
Ramps 50 mph
Frontage Rds 40 mph
Cross Streets 30 mph
Average Daily Traffic 2005 - 2025
= 130,500 - 243,500

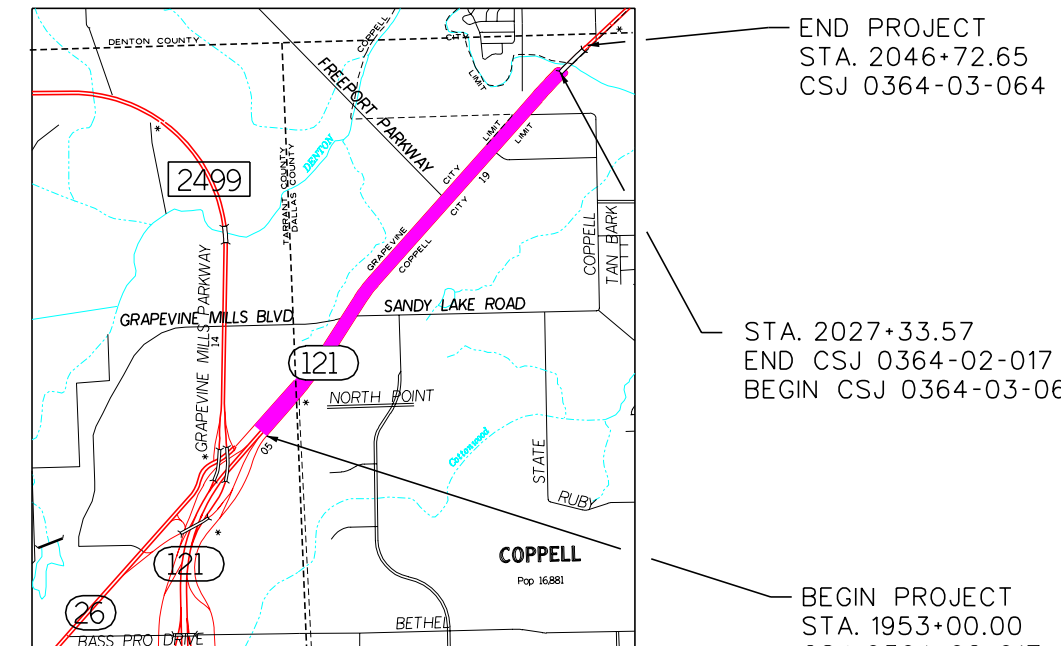

Scale:
Horizontal 1:200
Vertical 1:20

© 2005 by Texas Department of Transportation
all rights reserved
October 2005
Roll 2 of 3

SCHEMATIC PREPARED BY:
PHILLIP WAYNE ULLMAN
PROJECT MANAGER
7/4/2005
October 13, 2005
DATE

NOT INTENDED FOR
CONSTRUCTION,
BIDDING, OR
PERMIT PURPOSES

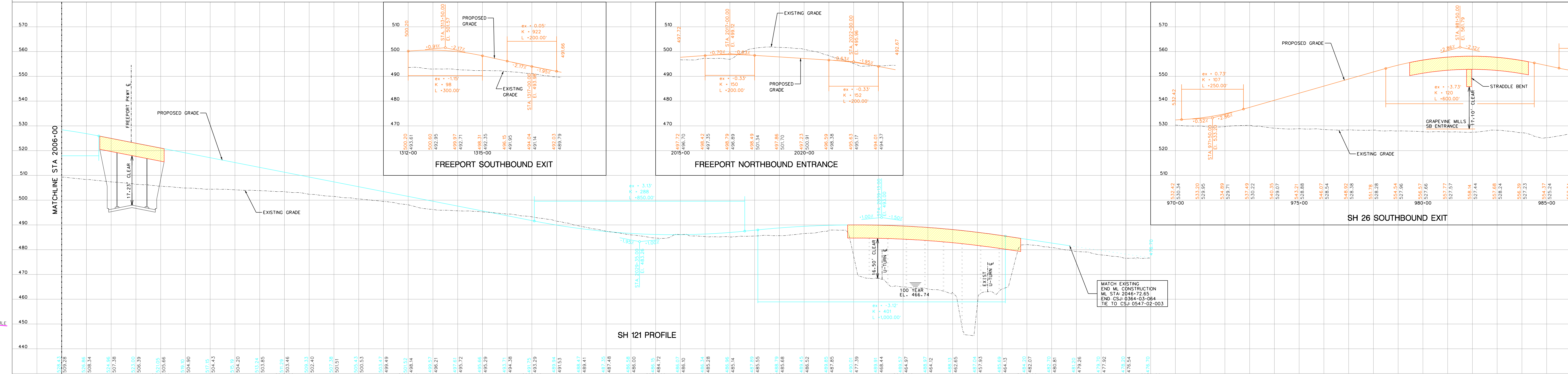
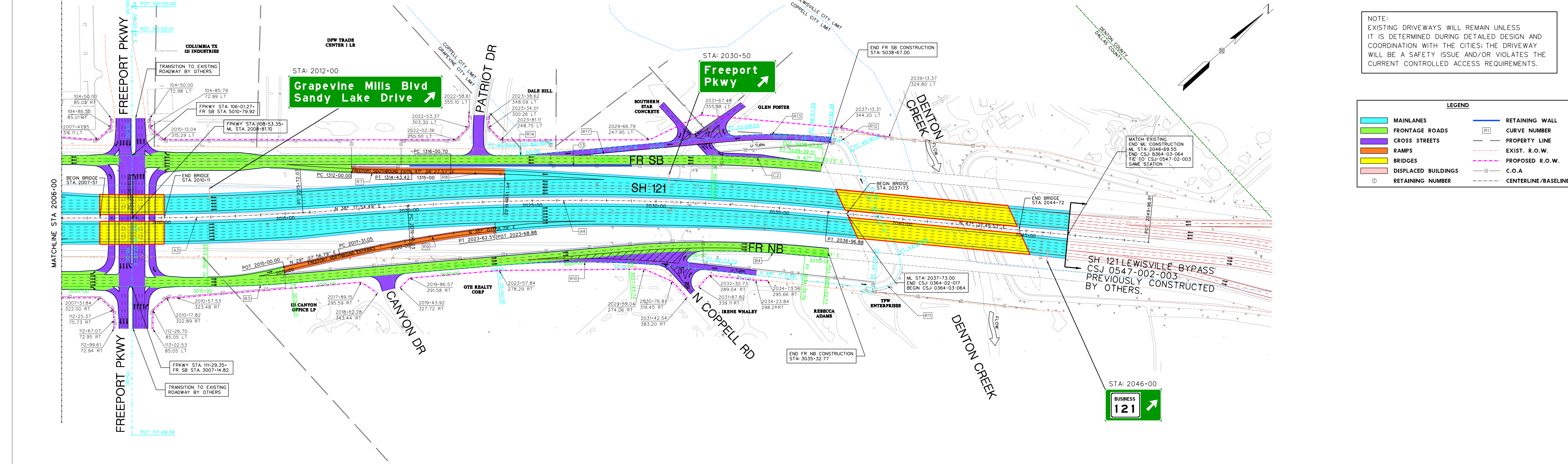
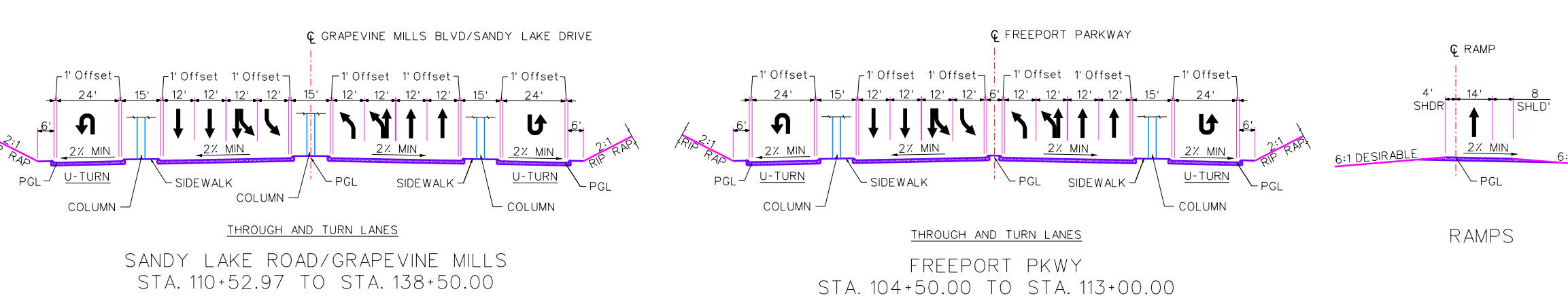
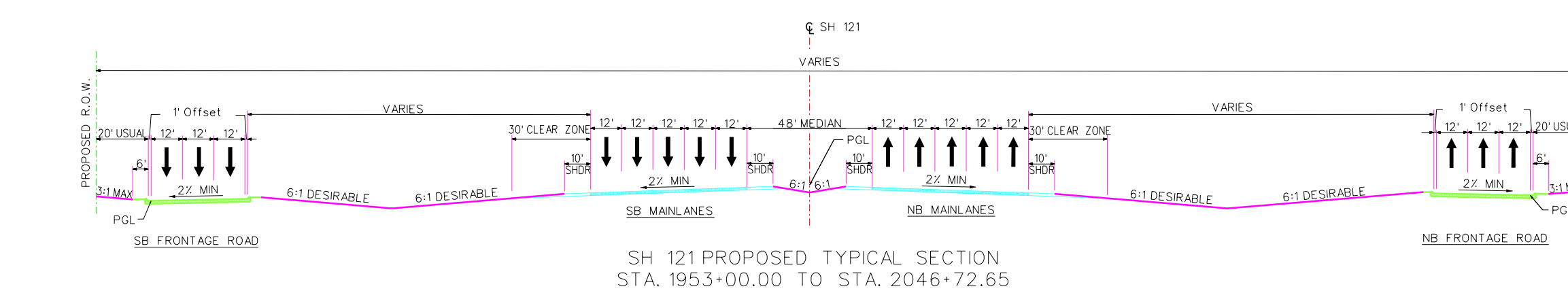
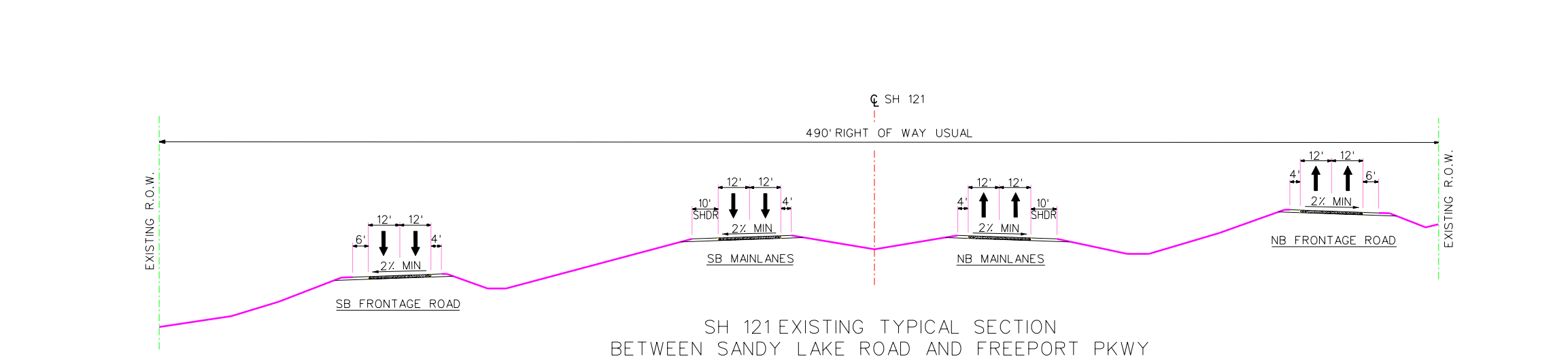
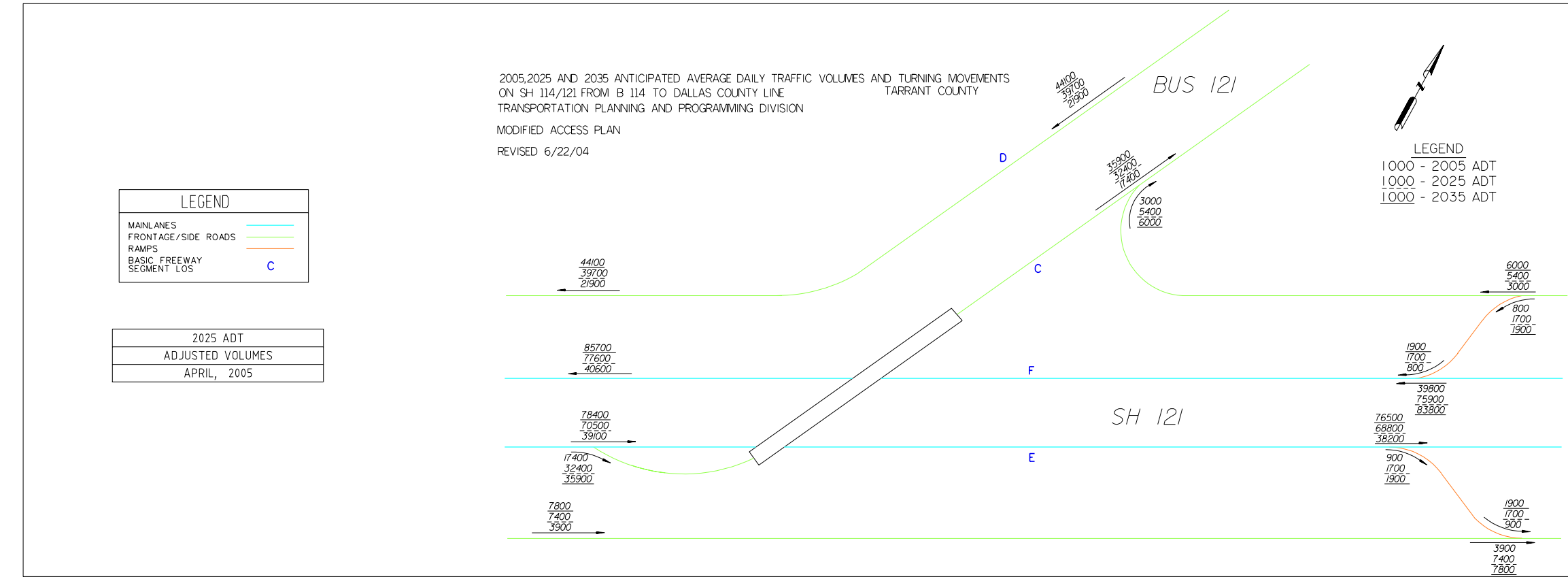
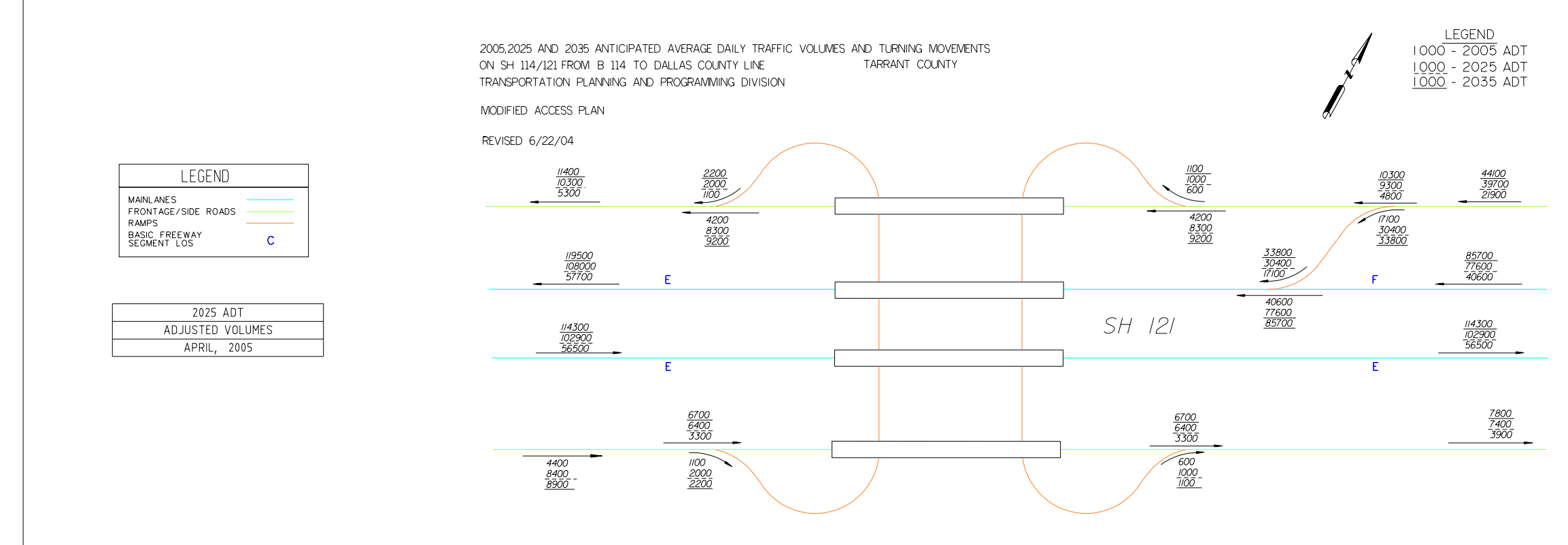

DALLAS DISTRICT
Design Schematic
William L. Hale, P.E.
District Engineer

SH 121
From: FM 2499
To: Denton Creek

Dallas County
CSJ: 0364-02-017
CSJ: 0364-03-064
Functional Class: Urban Freeway
Project Length: 1.94 Miles
Design Speed: Mainlanes 70 mph
Ramps 50 mph
Frontage Rds 40 mph
Cross Streets 30 mph
Average Daily Traffic 2005 - 2025
= 130,500 - 243,500

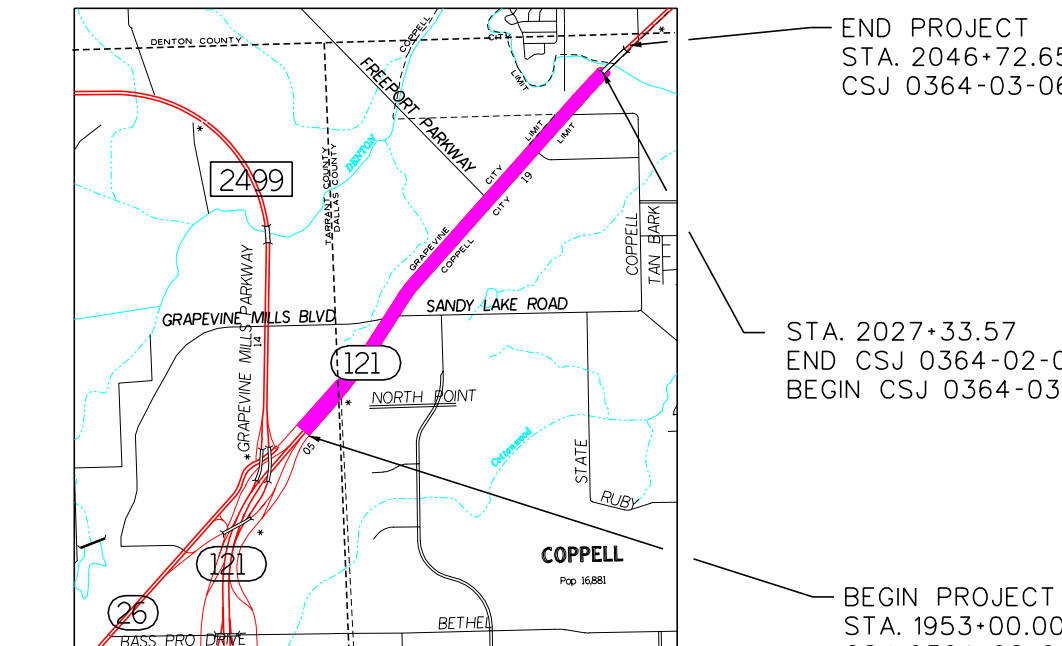

Scale:
Horizontal 1:200
Vertical 1:20

© 2005 by Texas Department of Transportation
all rights reserved
October 2005
Roll 2 of 3