

TEXAS DEPARTMENT OF TRANSPORTATION
DALLAS DISTRICT
WILLIAM HALE, P.E. - DISTRICT ENGINEER
CONCEPTUAL TOLL PLAN

SH 121
DENTON, DALLAS AND COLLIN COUNTIES

FROM DENTON CREEK TO WEST OF DALLAS NORTH TOLLWAY
CSJ: 3547-03-003 CSJ: 3547-02-004
CSJ: 3547-01-005 CSJ: 3547-01-008
CSJ: 3547-01-009 CSJ: 0364-03-086
CSJ: 0364-03-087 CSJ: 0364-04-039

PROJECT LENGTH= 13.4 MILES
DESIGN SPEED
MAINLANES - 70 MPH - BASED ON URBAN INTERSTATE FREEWAY
RAMPS - 50 MPH - BASED ON MID RANGE
DIRECT CONNECTORS - 50 MPH - BASED ON MID RANGE
FRONTAGE ROADS - 45 MPH
CROSS STREETS - 45 MPH (30 MPH WHERE NOTED)

HIGHWAY CLASSIFICATION
URBAN FREEWAY

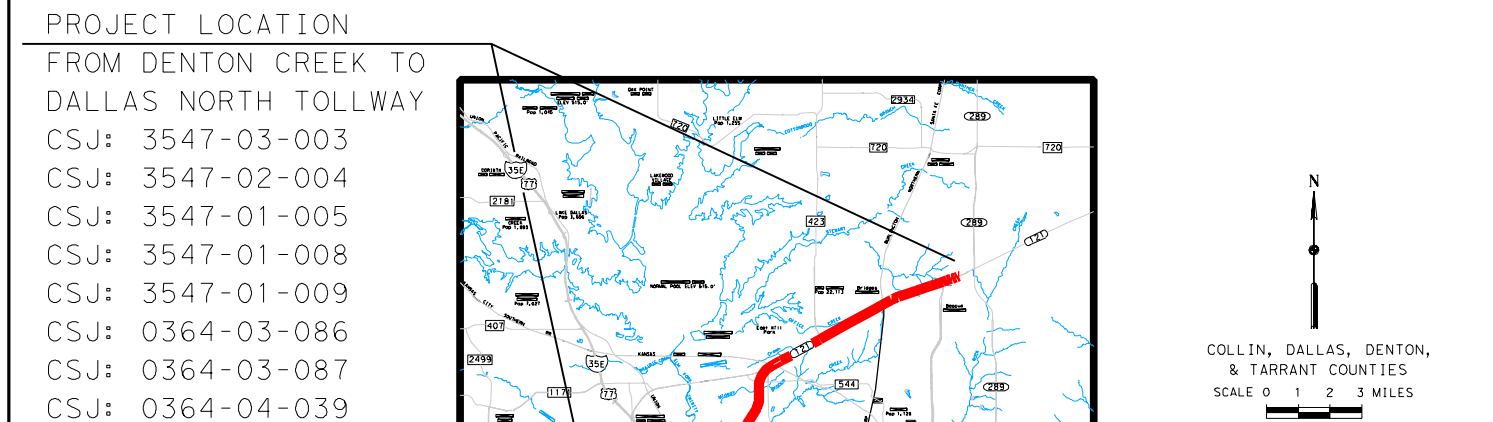

NAME SERIAL NO. XXXXX DATE: REVIEWED BY AZB: C. J. SHARKUS, P.E. SERIAL NO. 59627 DATE:

DATE APPROVED: NOT INTENDED FOR CONSTRUCTION, BIDDING OR PERMIT PURPOSES. DATE SUBMITTED: DATE REVISED:

TABLE OF CONTENTS: ROLLS PLAN/PROFILE 1-8 TRAFFIC VOLUMES 1-8 LARGE SIGNS 1-8 AUGUST 2005 ROLL 5 OF 8

© 2005 by Texas Department of Transportation: all rights reserved.

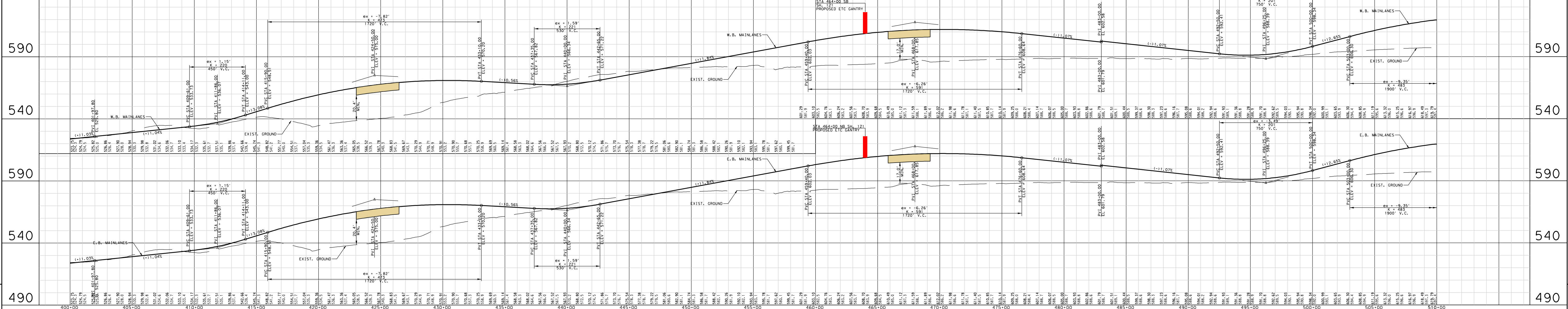
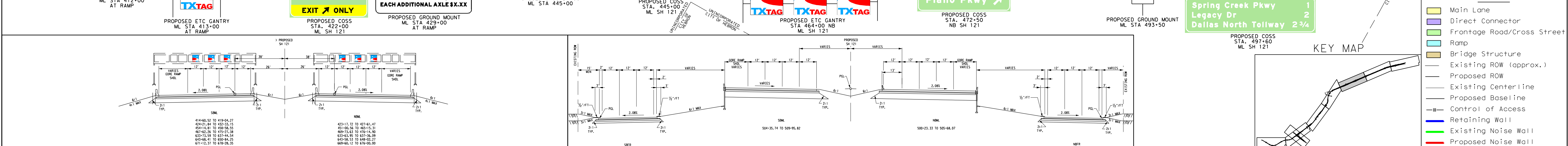
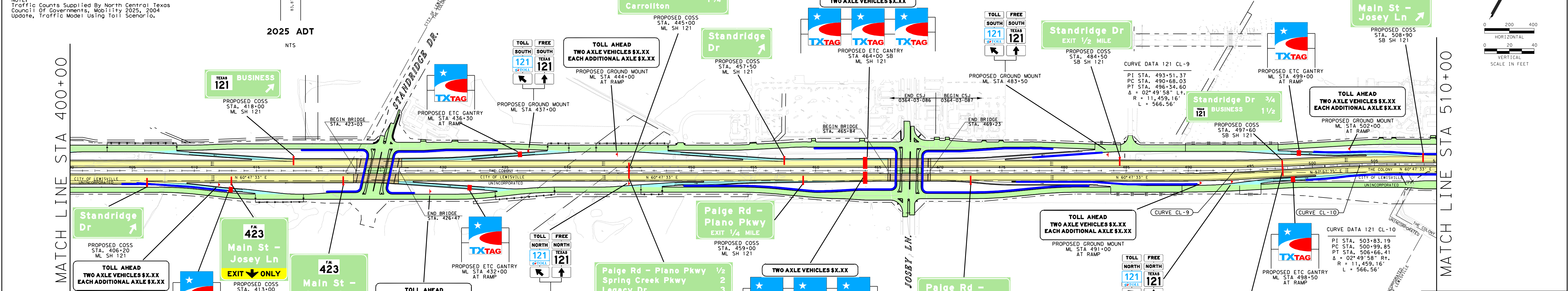
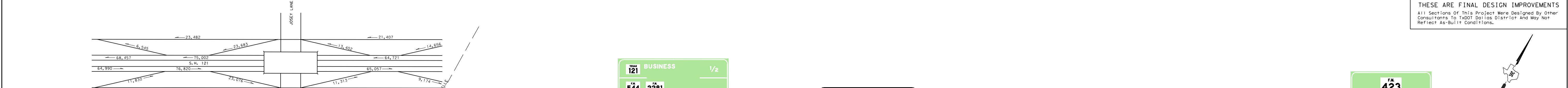
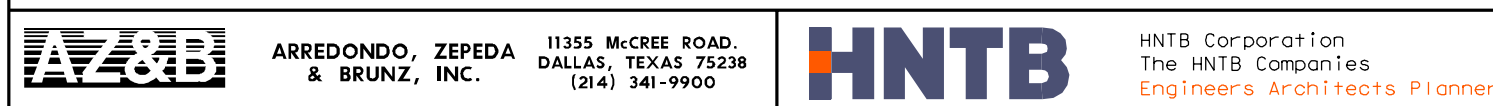

TEXAS DEPARTMENT OF TRANSPORTATION
DALLAS DISTRICT
WILLIAM HALE, P.E. - DISTRICT ENGINEER
CONCEPTUAL TOLL PLAN

SH 121
DENTON, DALLAS AND COLLIN COUNTIES

FROM DENTON CREEK TO WEST OF DALLAS NORTH TOLLWAY
CSJ: 3547-03-003 CSJ: 3547-02-004
CSJ: 3547-01-005 CSJ: 3547-01-008
CSJ: 3547-01-009 CSJ: 0364-03-086
CSJ: 0364-03-087 CSJ: 0364-04-039

PROJECT LENGTH= 13.4 MILES
DESIGN SPEED
MAINLANES - 70 MPH - BASED ON URBAN INTERSTATE FREEWAY
RAMPS - 50 MPH - BASED ON MID RANGE
DIRECT CONNECTORS - 50 MPH - BASED ON MID RANGE
FRONTAGE ROADS - 45 MPH
CROSS STREETS - 45 MPH (30 MPH WHERE NOTED)

HIGHWAY CLASSIFICATION
URBAN FREEWAY

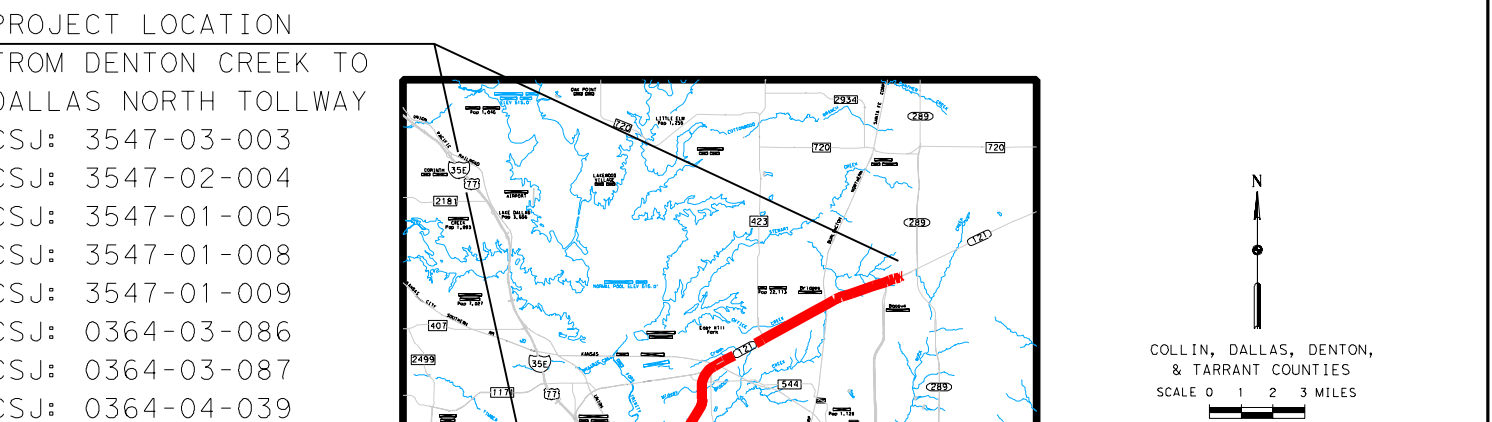

NAME SERIAL NO. XXXXX DATE: REVIEWED BY AZB: C. J. SHARKUS, P.E. SERIAL NO. 59627 DATE:

DATE APPROVED: NOT INTENDED FOR CONSTRUCTION, BIDDING OR PERMIT PURPOSES. DATE SUBMITTED: DATE REVISED:

TABLE OF CONTENTS: ROLLS PLAN/PROFILE 1-8 TRAFFIC VOLUMES 1-8 LARGE SIGNS 1-8 AUGUST 2005 ROLL 5 OF 8

© 2005 by Texas Department of Transportation: all rights reserved.

